

COMMAND LIGHT

# ELEVATE YOUR WORK LIGHTING

WORK AND  
TOW TRUCK  
LIGHTING





# WORK BRIGHTER (NOT HARDER IN THE DARK)

Command Light features a patented all-electric light tower design that provides endless positions to maximize directional lighting to increase work area visibility. Rotate the tower, backlight the space or overhang the vehicle with a Command Light tower. Plus, with roadway crew fatalities up year over year, scene lights and traffic flow boards are more essential than ever. Turn night into day.

# ELEVATE YOUR WORK LIGHTING

Command Light offers a variety of LED scene lighting solutions to illuminate any recovery scene or work area. As you consider your lighting options, ask yourself, ▼ “Can my truck-mounted lights do this?”

- ✓ **ELEVATE THE LIGHT SOURCE** to illuminate an area without creating the usual harsh, blinding glare
- ✓ **ROTATE 360 DEGREES** to direct valuable light
- ✓ **PROVIDE BACKLIGHTING\*** to illuminate dual scenes
- ✓ **DEPLOY IN 15 SECONDS OR LESS**
- ✓ Equip you with another tool that makes your services **EVEN MORE VALUABLE TO CUSTOMERS**

Command Light specializes in vehicle scene lighting, offering a patented light tower design that has been trusted for decades. To help you navigate Command Light’s broad lineup, this catalog is organized by tower height (ie. Series), the number of heads, light fixture selection and optional tower features.

## 1 SELECT THE IDEAL SIZE / PRODUCT



### UNLIMITED POSITIONING

THE KNIGHT SERIES  
Page 4

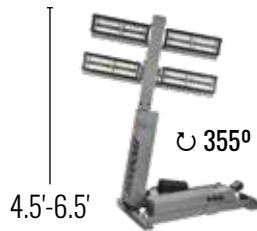

### INDUSTRY FAVORITE

THE SHADOW SERIES  
Page 5



### COMPACT LIGHTING

THE C-LITE  
Page 6



### TRAFFIC ADVISORS

ARROWS + BOARDS  
Page 7



### MOBILE LIGHTS

BATTERY POWERED!  
Pages 8-11

## 2 SPECIFY LIGHT SOURCE DETAILS

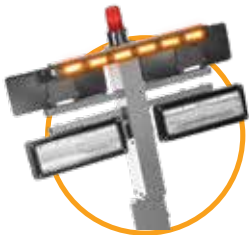

### NO. OF HEADS

CHOOSE BETWEEN 2 OR 4  
The number of heads will determine how much light you can gather and direct using rotation, angling and optional backlight.

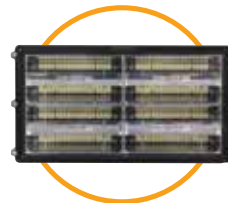

### LIGHT FIXTURES

DC-POWERED LEDS  
Choose from a variety of DC-powered LED fixtures with varying light output and power requirements. Select towers are available as AC-powered towers (115/230VAC).

## 3 ADD OPTIONAL FEATURES



### BACKLIGHT

The backlight option enables the bottom row of lamp heads to rotate 180°, making it possible to light both sides of the scene.



### TOP-MOUNTED STROBE

Alert oncoming traffic earlier with a strobe mounted on top of the light tower. Available in green, red, amber, blue or clear.



### LONG ARM

Get additional reach with an 80” long arm (on Shadow models).



### TOP-MOUNTED CAMERA

A top-mounted camera provides additional 360° views for operators, helping document the recovery process. Choose from the INTEC, Safety Vision or Zone Defense video systems. Learn more about these cameras at [commandlight.com/360-vehicle-cameras](http://commandlight.com/360-vehicle-cameras).



### CUSTOM COLORS

Optional colors include powder-coated white, red and black. Towers can be wet painted to any color. (Standard: Powder-coated gray.)



STANDARD



POWDER-COATED OPTIONS



WET PAINT  
(COLOR MATCH  
TO TRUCK)

# KL SERIES 7.5-FOOT REACH

**THE KNIGHT SERIES** delivers a reach of nearly 7.5 feet from its base. The Series also includes the KL Slim, a narrow tower with a small 53" x 13" footprint, perfect for small- to mid-size trucks, or wreckers with limited space.

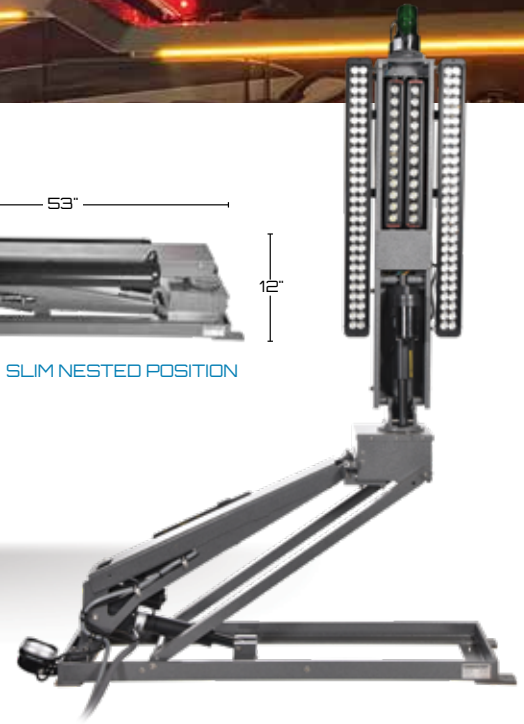
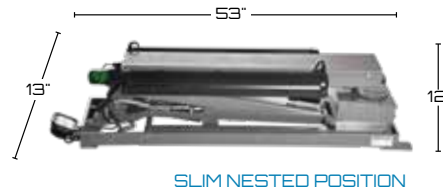

FRC Radiant Command



FRC Spectra



Whelen Pioneer Plus PFH2



FireTech 270w



FireTech 60w

4 HEAD	LIGHTING	POWER REQUIREMENTS	OUTPUT (PER LIGHT)	TOTAL OUTPUT	HXWXD (NESTED)	HXWXD (UPRIGHT)	WT.
KL415D-FR	FRC Radiant Command 120W	12V DC - 65 amps 780W	17,000 lumens	68,000 lumens	12" x 47" x 29" 305 mm x 1,195 mm x 735 mm	87.5" x 52" x 29" 2,225 mm x 1,320 mm x 735 mm	165 lbs 75 kg
KL415D-FS	FRC Spectra 220W	12V DC - 98 amps 1,180W	20,000 lumens	80,000 lumens	12" x 47" x 34" 305 mm x 1,195 mm x 865 mm	87.5" x 52" x 34" 2,225 mm x 1,320 mm x 865 mm	
KL415D-W2	Whelen Pioneer Plus PFH2 150w	12V DC - 63 amps 900w	20,261 lumens	81,044 lumens	12" x 47" x 34" 305 mm x 1,195 mm x 865 mm	87.5" x 52" x 34" 2,225 mm x 1,320 mm x 865 mm	
SLIM	LIGHTING	POWER	OUTPUT (PER LIGHT)	TOTAL OUTPUT	HXWXD (NESTED)	HXWXD (UPRIGHT)	WT.
KL409D-H4	(2) FireTech - 270W (2) FireTech - 60W	12V DC - 960W	270W: 28,500 60W: 6,500	70,000 lumens	12" x 53" x 13" 305 mm x 1,350 mm x 330 mm	87.5" x 53" x 13" 2,225 mm x 1,350 mm x 330 mm	165 lbs 75 kg

Select towers are available as AC/DC towers (12V DC + 114V or 230V AC). Please consult with a sales representative. Knight Slim requires 18" x 7" x 5" electrical box (mounted nearby).

**THE SHADOW SERIES** is ideal for rollbacks, tow trucks and utility vehicles. This compact 65-lb. tower has a reach of more than 4 feet from its base (or 6.5" with optional 80" arm) and provides 355° of rotation. Also, now available in a Slim design!

# SL SERIES

4.5- TO 6.5-FOOT REACH



Select towers are available as AC/DC towers (12V DC + 114V or 230V AC). Please consult with a sales representative.

2 HEAD	LIGHTING	POWER	OUTPUT (PER LIGHT)	TOTAL OUTPUT	HXWXD (NESTED)	HXWXD (UPRIGHT)	WT.
SL422D-FR	FRC Radiant Command 120W	12V DC – 35 amps 420W	17,000 lumens	34,000 lumens	8" x 54" x 28" 205 mm x 1,375 mm x 710mm	55" x 36" x 28" 1,395 mm x 915 mm x 710 mm	65 lbs 30 kg
SL422D-FS	FRC Spectra 220W	12V DC – 42 amps 620W	20,000 lumens	40,000 lumens	8" x 54" x 34" 205 mm x 1,375 mm x 865 mm	55" x 36" x 34" 1,395 mm x 915 mm x 865 mm	
SL422D-W1	Whelen Pioneer Plus PCH1 75W	12V DC* – 20 amps 330W	10,130 lumens	20,260 lumens	8" x 54" x 22" 205 mm x 1,375 mm x 560 mm	55" x 36" x 22" 1,395 mm x 915 mm x 560 mm	
SL422D-W2	Whelen Pioneer Plus PFH2 150W	12V DC* – 35 amps 480W	20,261 lumens	40,522 lumens	8" x 54" x 33" 205 mm x 1,375 mm x 840 mm	55" x 36" x 33" 1,395 mm x 915 mm x 840 mm	
4 HEAD	LIGHTING	POWER REQUIREMENTS	OUTPUT (PER LIGHT)	TOTAL OUTPUT	HXWXD (NESTED)	HXWXD (UPRIGHT)	WT.
SL442D-CH	FireTech Helios 60W	12V DC – 35 amps 420W	14,000 lumens	56,000 lumens	8" x 54" x 28" 205 mm x 1,375 mm x 710 mm	55" x 36" x 28" 1,395 mm x 915 mm x 710 mm	75 lbs 35 kg
SL442D-FR	FRC Radiant Command 120W	12V DC – 65 amps 780W	17,000 lumens	68,000 lumens	8" x 54" x 28" 205 mm x 1,375 mm x 710 mm	55" x 36" x 28" 1,395 mm x 915 mm x 710 mm	
SL442D-FS	FRC Spectra 220W	12V DC – 90 amps 1,060W	20,000 lumens	80,000 lumens	8" x 54" x 34" 205 mm x 1,375 mm x 865 mm	55" x 36" x 34" 1,395 mm x 915 mm x 865 mm	
SL442D-LX	Lightforce HTX LED/HID 150W	12V DC – 65 amps 780W	13,500 lumens	54,000 lumens	8" x 56" x 23" 203 mm x 1,422 mm x 585 mm	57" x 46" x 23" 1,448 mm x 1,169 mm x 585 mm	
SL442D-W1	Whelen Pioneer Plus PCH1 75W	12V DC* – 40 amps 480W	10,130 lumens	40,520 lumens	8" x 54" x 22" 205 mm x 1,375 mm x 560 mm	55" x 36" x 22" 1,395 mm x 915 mm x 560 mm	
SL442D-W2	Whelen Pioneer Plus PFH2 150W	12V DC* – 65 amps 780W	20,261 lumens	81,044 lumens	8" x 54" x 33" 205 mm x 1,375 mm x 835 mm	55" x 36" x 33" 1,395 mm x 915 mm x 835 mm	
SLIM	LIGHTING	POWER	OUTPUT (PER LIGHT)	TOTAL OUTPUT	HXWXD (NESTED)	HXWXD (UPRIGHT)	WT.
SL423D-H2	(2) FireTech – 270W	12V DC – 720W	28,500 lumens	57,000 lumens	8" x 63" x 11" 605 mm x 1,600 mm x 280mm	66" x 42" x 11" 1,675 mm x 1,600 mm x 280 mm	65 lbs 35 kg

# COMPACT LIGHTING



## C-LITE

The C-Lite is a versatile, compact unit that boasts a LED spotlight/floodlight combo, creating a concentrated beam that allows the operator to illuminate areas not typically reached by fixed lights. The C-Lite has the ability to tilt up to 120° and even rotate with an optional platform. This unit's small, lightweight design can be mounted vertically or horizontally.



DC	LIGHTING	POWER REQUIREMENTS	OUTPUT (PER LIGHT)	TOTAL OUTPUT	HXWXD (NESTED)	HXWXD (UPRIGHT)	WT.
CD113D-CH	(1) FireTech Helios 60W	12V DC - 12 amps 140W	14,000 lumens	14,000 lumens	9" x 12" x 19" 230 mm x 305 mm x 485 mm	21" x 12" x 19" 535 mm x 355 mm x 485 mm	35 lbs 16 kg
CD113D-FR	(1) FRC Radiant Command 120W	12V DC - 16 amps 200W	17,000 lumens	17,000 lumens	9" x 14" x 19" 230 mm x 355 mm x 485 mm	21" x 14" x 19" 535 mm x 355 mm x 485 mm	
CD128D-FN	(2) FRC Mini Spectra 130W	12V DC - 29 amps 340W	14,000 lumens	28,000 lumens	9" x 26" x 19" 230 mm x 660 mm x 485 mm	21" x 26" x 19" 535 mm x 660 mm x 485 mm	30 lbs 13 kg
CD127D-W1	(2) Whelen Pioneer Plus PCH1 75W	12V DC - 20 amps 230W	10,130 lumens	20,260 lumens	9" x 19" x 19" 230 mm x 485 mm x 485 mm	21" x 19" x 19" 510 mm x 485 mm x 485 mm	



# ADVISORY LIGHTING



## TRAFFIC FLOW BOARDS

With rotational capabilities and multiple arrow patterns, Command Light's Traffic Flow Boards significantly improve on-site visibility and tow operator safety. Available in five different traffic patterns, these units conserve space when stowed. Each model comes with standard rotation, giving crews the ability to position traffic advisory arrows toward traffic to maximize effectiveness during blocking modes.

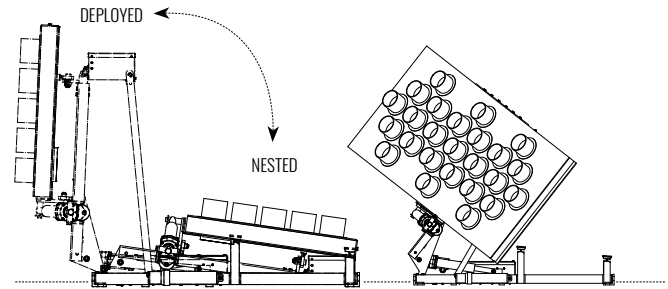

TFB-H7





TFB-H5



TFB-SL3



TFB-HM2

	MOVEMENT	TRAFFIC PATTERN	POWER REQUIREMENTS	HXWXD (NESTED)	HXWXD (UPRIGHT)	WT.
<b>TFB-H7</b>	Fold-down design	 Greatest pattern variety	12V DC - 5 amps	16" x 60" x 46" 406 mm x 1,524 mm x 1,168 mm	44" x 60" x 66" 1,118 mm x 1,524 mm x 1,676 mm	150 lbs 68 kg
<b>TFB-H5</b>	Fold-down design	 Essential traffic patterns	12V DC - 5 amps	8" x 48" x 40" 203 mm x 1,219 mm x 1,106 mm	52" x 70" x 40" 1,321 mm x 1,778 mm x 1,016 mm	80 lbs 36 kg
<b>TFB-SL3</b>	Fold-down design, mounted to a Shadow Series tower	 Directional light bar	12V DC - 5 amps + tower requirements	Variable based on tower selection	Variable based on tower selection	14 lbs + tower
<b>TFB-HM2</b>	Horizontal fold-down ± 45° rotation	2-lines of text or arrows	12V DC - 27 amps 325w	16" x 73" x 52" 405mm x 1,855mm x 1,320mm	50" x 75" x 61" 1,270mm x 1,905mm x 1,550mm	220 lbs 100 kg
<b>TFB-HM3</b>	Horizontal fold-down ± 45° rotation	3-lines of text or arrows	12V DC - 38 amps 450w	16" x 73" x 66" 405mm x 1,855mm x 1,675mm	64" x 75" x 61" 1,625mm x 1,905 mm x 1,550 mm	240 lbs 110 kg

## THE ONLY TRIPOD THAT LETS YOU CHOOSE:

### YOUR POWER SOURCE ...

- ✓ AC POWER
- ✓ TRUCK 12V DC
- ✓ DEWALT® FLEXVOLT™
- ✓ MAKITA® XGT
- ✓ MILWAUKEE® M28

### YOUR LED HEAD...

- ✓ FRC RADIANT COMMAND
- ✓ FRC SPECTRAS
- ✓ FIRETECH GUARDIAN ELITE
- ✓ FIRETECH HELIOS
- ✓ WHELENS
- ✓ ARROW STICKS
- ✓ MESSAGE BARS



PLUS, MEET THE NEW BATTERY-POWERED  
EOS-RDL (RAPID DEPLOY LIGHT)



# LIGHTS

## BATTERY POWERED!

Command Light continues to elevate scene lighting, this time revolutionizing the mobile lighting market with the introduction of its new battery-powered EOS-RDL (Rapid Deploy Light), which joins the Trident Tripod. Both lights let crews choose their power source and favorite high-powered LED!



# BATTERY TRIPODS

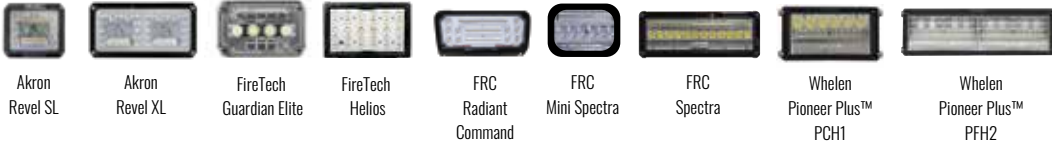

## DC LEADS

### ESTIMATED RUN TIME \*\*

DC	LIGHTING	POWER REQ.	WT.*	TOTAL OUTPUT	ESTIMATED RUN TIME **							
					DeWalt FLEXVOLT 9Ah	DeWalt FLEXVOLT 12Ah	DeWalt FLEXVOLT 15Ah	Makita XGT 4Ah	Makita XGT 5Ah	Makita XGT 8Ah	Milwaukee M28 3Ah	Milwaukee M28 5Ah
TXXD-AR-BX	Akron Revel SL	110W	25 lbs 11 kg	14,000 lumens	85 minutes	110 minutes	132 minutes	75 minutes	93 minutes	135 minutes	64 minutes	102 minutes
TXXD-AX-BX	Akron Revel XL	220W	35 lbs 16 kg	28,000 lumens	42 minutes	55 minutes	66 minutes	37 minutes	46 minutes	69 minutes	32 minutes	51 minutes
TXXD-HE-BX	FireTech Guardian Elite	120W	40 lbs 18 kg	20,500 lumens	86 minutes	114 minutes	135 minutes	76 minutes	92 minutes	136 minutes	68 minutes	107 minutes
TXXD-CH-BX	FireTech Helios	60W	30 lbs 13 kg	14,000 lumens	135 minutes	175 minutes	210 minutes	94 minutes	150 minutes	220 minutes	96 minutes	153 minutes
TXXD-FN-BX	FRC Mini Spectra	130W	35 lbs 16 kg	14,000 lumens	79 minutes	105 minutes	126 minutes	70 minutes	85 minutes	125 minutes	62 minutes	99 minutes
TXXD-FR-BX	FRC Radiant Command	120W	35 lbs 16 kg	17,000 lumens	86 minutes	114 minutes	135 minutes	76 minutes	92 minutes	132 minutes	68 minutes	107 minutes
TXXD-FS-BX	FRC Spectra	220W	30 lbs 13 kg	20,000 lumens	49 minutes	64 minutes	75 minutes	40 minutes	50 minutes	74 minutes	34 minutes	54 minutes
TXXD-W1-BX	Whelen PCH1	75W	25 lbs 11 kg	10,130 lumens	145 minutes	192 minutes	225 minutes	130 minutes	160 minutes	235 minutes	105 minutes	172 minutes
TXXD-W2-BX	Whelen PFH2	150W	30 lbs 13 kg	20,261 lumens	74 minutes	96 minutes	112 minutes	65 minutes	81 minutes	122 minutes	54 minutes	86 minutes
TXXD-LB-BX	60w Fenix Light Bar***	60W Max	35 lbs 16 kg	Arrow patterns and floodlight	150 minutes	200 minutes	235 minutes	120 minutes	150 minutes	220 minutes	100 minutes	165 minutes
TXXD-FBA-BX	Amber Federal Message Bar	90W Max	35 lbs 16 kg	Digital message	100 minutes	133 minutes	155 minutes	80 minutes	100 minutes	145 minutes	67 minutes	110 minutes
TXXD-FBB-BX	Blue Federal Message Bar	90W Max	35 lbs 16 kg	Digital message	100 minutes	133 minutes	155 minutes	80 minutes	100 minutes	145 minutes	67 minutes	110 minutes

**BX = DC OPTIONS**

Replace BX with power designation from chart on right.

**TXX = TRIPOD HEIGHT**

T40 = 40" Tripod

T50 = 50" Tripod

DC LED CHART DISCLAIMERS

\* Weights listed with no options.

\*\* Reported run times based on fully charged batteries at 70° F; temperature and battery condition can impact tripod performance. Light blinks three times to warn of low-battery conditions.

\*\*\* Light/message bar run times based on floodlight pattern. Multiply minutes by 2 for average arrow patterns.

## MODEL ORDERING GUIDE

### DC MODELS T

**T50D-W2-BD-12-SP-TP**

T40 = 40" Tripod; T50 = 50" Tripod  
 D = 12V DC  
 LED Selection  
 Battery / Charger Selection  
 Battery Ah  
 Shore Power Option  
 Truck Power Option

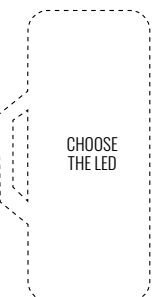

ADJUSTABLE LEG EXTENSION



DeWalt® FLEXVOLT™



Makita® XGT



Milwaukee® M28



Truck 12V DC

## DC POWER OPTIONS

DC OPTIONS*	DESCRIPTION
<b>DELETE BX*</b>	No Battery Capability, 12V DC-Powered Tripod ONLY
<b>BD</b>	Battery Option - DeWalt FLEXVOLT Ready
<b>BD-09</b>	DeWalt FLEXVOLT 9Ah Battery and Fast Charger
<b>BD-12</b>	DeWalt FLEXVOLT 12Ah Battery and Fast Charger
<b>BD-15</b>	DeWalt FLEXVOLT 15Ah Battery and Fast Charger
<b>BK</b>	Battery Option - Makita XGT Ready
<b>BK-04</b>	Battery Option - Makita XGT 4Ah Battery and Charger
<b>BK-05</b>	Battery Option - Makita XGT 5Ah Battery and Charger
<b>BK-08</b>	Battery Option - Makita XGT 8Ah Battery and Charger
<b>BW</b>	Battery Option - Milwaukee M28 Ready***
<b>SP**</b>	120V AC Shore Power Option - 15A Plug
<b>TP</b>	12V DC Truck Power Option
<b>TP-MB</b>	12V DC Truck Power Option + Truck Mounting Brackets with Quick Disconnect

BUNDLES	MODEL	DESCRIPTION
<b>POWER BUNDLES</b>	<b>TXXD-FS-BD-12-SP</b>	40" or 50" Tripod, 220W FRC Spectra LED x 1, DeWalt 12Ah Battery + Charger, 120V AC Shore Power
	<b>TXXD-FS-BK-05-SP</b>	40" or 50" Tripod, 220W FRC Spectra LED x 1, Makita 5Ah Battery + Charger, 120V AC Shore Power
<b>BALANCED BUNDLES</b>	<b>TXXD-W2-BD-12-SP</b>	40" or 50" Tripod, 150W Whelen PFH2 LED x 1, DeWalt 12Ah Battery and Charger, 120V AC Shore Power
	<b>TXXD-W2-BK-05-SP</b>	40" or 50" Tripod, 150W Whelen PFH2 LED x 1, Makita 5Ah Battery + Charger, 120V AC Shore Power
<b>RUN-TIME BUNDLES</b>	<b>TXXD-CH-BD-12-SP</b>	40" or 50" Tripod, 60W FireTech Helios LED x 1, DeWalt 12Ah Battery + Charger, 120V AC Shore Power
	<b>TXXD-CH-BK-05-SP</b>	40" or 50" Tripod, 60W FireTech Helios LED x 1, Makita 5Ah Battery + Charger, 120V AC Shore Power
<b>VALUE BUNDLES</b>	<b>TXXD-AR-BD-09-SP</b>	40" or 50" Tripod, 110W Akron Revel SL LED x 1, DeWalt 9Ah Battery + Charger, 120V AC Shore Power
	<b>TXXD-AR-BK-04-SP</b>	40" or 50" Tripod, 110W Akron Revel SL LED x 1, Makita 4Ah Battery + Charger, 120V AC Shore Power

DC POWER OPTION DISCLAIMERS:

\* Must pick 1 Battery Option or Truck Power Option.

\*\* Shore Power only available in addition to a Battery Option.



## THE NEW EOS-RDL RAPID DEPLOY LIGHT



Akron Revel SL



FireTech Guardian Elite



FRC Mini Spectra



Whelen Pioneer Plus™ PCH1

## DC LEDS

DC	LIGHTING	POWER REQ.	WT.*	TOTAL OUTPUT
<b>RL11D-AR-BX</b>	Akron Revel SL ****	110W	10 lbs 4.5 kg	14,000 lumens
<b>RL11D-HE-BX</b>	FireTech Guardian Elite	120W	13 lbs 6 kg	20,500 lumens
<b>RL11D-FN-BX</b>	FRC Mini Spectra	130W	11 lbs 5 kg	14,000 lumens
<b>RL11D-W1-BX</b>	Whelen PCH	75W	9 lbs 4 kg	10,130 lumens

ESTIMATED RUN TIMES: Please reference the run times in the LED chart, left on Page 10.

\* Weights listed with no options.



DeWalt® FLEXVOLT™



Makita® XGT



Milwaukee® M28

## DC POWER OPTIONS

DC OPTIONS*	DESCRIPTION
<b>BD</b>	Battery Option - DeWalt FLEXVOLT Ready
<b>BD-09</b>	DeWalt FLEXVOLT 9Ah Battery and Fast Charger
<b>BD-12</b>	DeWalt FLEXVOLT 12Ah Battery and Fast Charger
<b>BD-15</b>	DeWalt FLEXVOLT 15Ah Battery and Fast Charger
<b>BK</b>	Battery Option - Makita XGT Ready
<b>BK-04</b>	Battery Option - Makita XGT 4Ah Battery and Charger
<b>BK-05</b>	Battery Option - Makita XGT 5Ah Battery and Charger
<b>BK-08</b>	Battery Option - Makita XGT 8Ah Battery and Charger
<b>BW</b>	Battery Option - Milwaukee M28 Ready***
<b>SP</b>	120V AC Shore Power Option - 15A Plug



BACKED BY AN INDUSTRY-LEADING  
**5-YEAR WARRANTY**

Command Light products come with an industry-leading, five-year warranty against any defects in materials and workmanship when used and operated for a period of five years. Excludes malfunctions related to misuse, accident, neglect or normal wear-and-tear, as well as light-producing components (bulbs, lasers, LEDs), which come with their own manufacturer's warranty.

**COMMAND LIGHT**

[COMMANDLIGHT.COM](http://COMMANDLIGHT.COM) | 800.797.7974 | 3842 REDMAN DR. FORT COLLINS CO 80524

See a Command Light representative or authorized dealer for details. All information in this brochure is the latest available at the time of publication. Printed in the USA. 500 0124 ©2024 Command Light