

COMMAND LIGHT

ENHANCE YOUR SCENE LIGHTING

YOUR
PARTNER
IN CRIME
AND SAFETY



WHICH TOWER IS RIGHT FOR YOU?

With more than 50 years in emergency lighting, Command Light offers a variety of elevated police light systems for police cars, crime units and command vehicles, taking your warning and emergency scene lighting to the next level. To help you navigate Command Light's broad lineup, this catalog is organized by tower height (ie. Series), number of heads, power requirements and optional features.

1 SELECT THE IDEAL HEIGHT

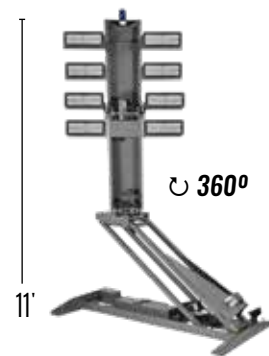

CL SERIES
MOST POWERFUL TOWER
Pages 6-7



KNIGHT SERIES
MID-SIZE HEIGHT
Pages 8-9



SHADOW SERIES
SHORTEST TOWER
Pages 10-12



C-LITE
COMPACT LIGHTING
Page 13

CHOOSE YOUR FIXTURE/POWER CONFIGURATION



2 # OF HEADS CHOOSE FROM 1, 2, 4, 6 OR 8

The number of heads will determine how much light you can gather and direct using rotation, angling and optional backlight.

- 8 HEAD Page 6
- 6 HEAD Pages 7-8
- 4 HEAD Pages 7, 9, 11
- 2 HEAD Pages 12-13
- 1 HEAD Page 13



3 POWER AC OR DC

Do you need an AC (115/230V) powered unit, a DC (12V or 24V) power or a combination of both? Look for the **AC** and **DC** chart labels to help you note the tower's power requirements.

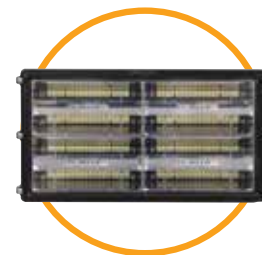

4 LIGHT FIXTURES LED OR QUARTZ HALOGEN

Looking for LEDs (long-lasting lamps at a lower power draw), or quartz halogen (bright fixtures for less cost)? Refer to the **LEDs** and **QUARTZ HALOGEN** labels.

MORE INFO Pages 4-5

For Traffic Advisors, please see Pages 14-15

ADD OPTIONAL FEATURES

5 UPGRADES



BACKLIGHT

Command Light's backlight option enables the bottom row of lamp heads to rotate 180°, making it possible to light both sides of a scene.



TOP-MOUNTED STROBE

Alert oncoming traffic earlier with a strobe, mounted on top of the light tower. Available in green, red, amber, blue or clear.



LONG ARM

Increase the Shadow Series' reach, up to 6.5' with this optional arm.



CUSTOM COLORS

Optional colors include powder-coated white and black. Towers can be wet painted to any color. (Standard: Powder-coated gray.)



TOP-MOUNTED CAMERA

A top-mounted camera provides additional 360° views, allowing responders to view and capture all angles of a scene. Choose from the INTEC, Safety Vision or Zone Defense video systems. Learn more about these cameras at commandlight.com/360-vehicle-cameras.



CONTROL OPTIONS



STANDARD

The Standard Controller comes with a 15 ft (4.5 m) umbilical cord and intuitive buttons, giving crews the ability to control every aspect of the tower and lights.



WIRELESS

Available on any Command Light tower, this optional Wireless Controller has a range of up to 150 ft (45 m) and supplements the Standard Controller.



PANEL-MOUNTED

This Panel-Mounted Controller can be added to a compartment or any protected area. Available on all towers, this option can be used alone or with another controller.







V-MUX / CLASS 1

Operate your light tower via V-Mux or Class 1 in-cab controls, which supplement the Standard Controller and are available on all Command Light towers.









All fixtures specifications are provided by the manufacturer and are subject to change; all information is the latest available at the time of publication.

LEDs

LEDs produce long-lasting, energy-efficient lighting by passing a current through a semi-conductor rich in electrons and a semi-conductor that is rich in holes to produce photons – the light that you see.

AC	LEDs	POWER	TOTAL WATTS	OUTPUT
HELIOS*	 Exclusive Command Light fixture that delivers an economical LED!	115V or 230V AC	60W	14,000 lumens
FRC SPECTRA	 Spot/flood combination	115V or 230V AC	220W	20,000 lumens
FIRETECH HIVIZ	 Knight Slim exclusive, featuring two 270-watt and two 60-watt fixtures	115V AC	60W 270W	6,500 lumens 28,500 lumens
WHELEN PIONEER PLUS PCP2**	 Spot/flood combination	115V or 230V AC	150W	20,614 lumens
WHELEN PIONEER PLUS PFP2	 Dual panel with flood light	115V or 230V AC	150W	20,442 lumens
WHELEN PIONEER PLUS PFP4	 Quad panel with flood light and Whelen's highest luminous output	115V or 230V AC	300W	40,884 lumens



* An exclusive Command Light fixture, manufactured by FireTech. ** Upgrade from standard Whelen flood to spot/flood combo upon request.

DC		POWER	TOTAL WATTS	OUTPUT
HELIOS*	 Exclusive Command Light fixture that delivers an economical LED!	12V or 24V DC	60W	14,000 lumens
FRC EVOLUTION	 Parabolic reflector that illuminates action and working area	12V or 24V DC	160W	20,000 lumens
FRC SPECTRA	 Uniform flood and spot combination of super bright, white light	12V or 24V DC	220W	20,000 lumens
FIRETECH HIVIZ	 Knight Slim exclusive, featuring two 270-watt and two 60-watt fixtures	12V or 24V DC	60W 270W	6,500 lumens 28,500 lumens
FIRETECH SL-X-15***	 More output with less power consumption	12V or 24V DC	185W	15,306 lumens
LIGHTFORCE HTX	 Combines 20 LEDs for flood beam - HID bulb for 1,932 yards of viewing	12V or 24V DC	150W	13,500 lumens
WHELEN PIONEER PLUS PCH1	 Single panel with combo flood/spot and Proclera® silicone optics	12V or 24V DC	75W	10,130 lumens
WHELEN PIONEER PLUS PCH2**	 Spot/flood combination	12V or 24V DC	150W	20,261 lumens
WHELEN PIONEER PLUS PFH2	 Dual panel with combo flood/spot and Proclera® silicone optics	12V or 24V DC	150W	20,261 lumens

* An exclusive Command Light fixture, manufactured by FireTech. ** Upgrade from standard Whelen flood to spot/flood combo upon request. *** Available upon request.

QUARTZ HALOGEN

The quartz halogen bulb is a type of incandescent bulb that has been refined to produce more light per unit of energy. The filament tube has a small amount of halogen gas in it to prevent bulb darkening and filament evaporation, which increases the bulb life while producing crisp light.

AC	QUARTZ HALOGEN	POWER	TOTAL WATTS	OUTPUT
HUBBELL QUARTZLITER	 Full fixture that runs at or below rated temperature for 2,000-hour life	115V or 230V AC	500W 750W 1,000W 1,500W	11,100 lumens 16,500 lumens 21,500 lumens 35,800 lumens
FRC FOCUS	 Reflector redirects and focuses light	115V or 230V AC	750W	19,600 lumens
LUMENFORM	 Industrial-grade quartz halogen luminary	115V or 230V AC	500W	11,100 lumens

LED RETROFITS

Lengthen the lifespan of your quartz halogen tower by converting it to LED!

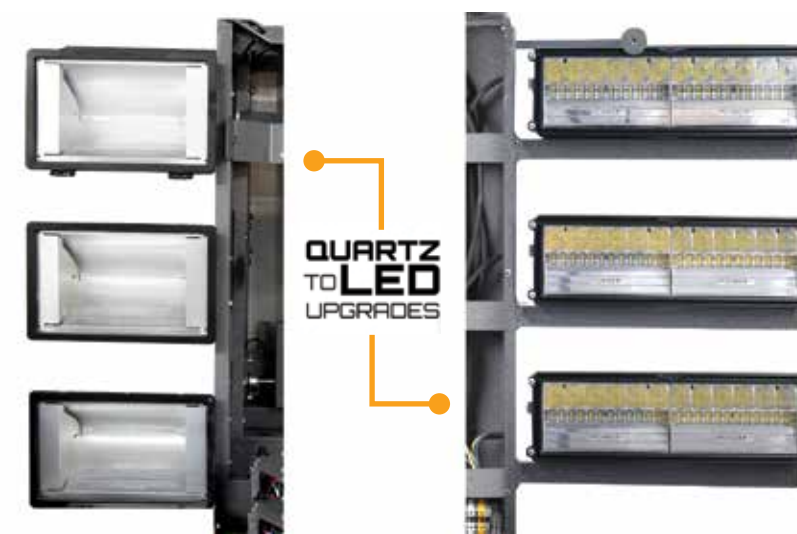

- ✓ Retrofit most in-service quartz halogen 2-, 4- and 6-head towers
- ✓ Update to the latest LED technology from FRC, Whelen and Command Light's very own retrofit fixture, Helios
- ✓ With just your Command Light serial number, we can determine if your tower can be upgraded
- ✓ Cost varies based on fixture selection, complexity of upgrade and the number of heads

SLs and KLs include new lamp trees; CLs include new lamp brackets. Note: Upgrade pricing is not valid on towers less than 1 year old.



See before-and-after footage of a Command Light LED retrofit at bit.ly/LED-retrofit.

CL SERIES

TOWERS WITH 11-FOOT REACH



QUESTIONS? CUSTOM TOWER INQUIRIES?
CONTACT US AT [INFO@COMMANDLIGHT.COM](mailto:info@commandlight.com)

OPTIONS (SEE PAGE 3 FOR DESCRIPTIONS)



6 HEAD

LEDs



AC	LIGHTING	POWER REQUIREMENTS	OUTPUT (PER LIGHT)	TOTAL OUTPUT	HxWxD (NESTED)	HxWxD (UPRIGHT)	WT.
CL602A-FS	FRC Spectra 220W	115V or 230V AC 1,620W	20,000 lumens	120,000 lumens	12" x 74" x 43" 305 mm x 1,880 mm x 1,095 mm	131" x 79" x 43" 3,330 mm x 2,010 mm x 1,095 mm	305 lbs 139 kg
CL602A-W2	Whelen Pioneer Plus PFP2 150W	115V or 230V AC 1,200W	20,442 lumens	122,652 lumens	12" x 74" x 43" 305 mm x 1,880 mm x 1,095 mm	131" x 79" x 43" 3,330 mm x 2,010 mm x 1,095 mm	
CL602A-W4	Whelen Pioneer Plus PFP4 300W	115V or 230V AC 2,100W	40,884 lumens	245,304 lumens	12" x 74" x 43" 305 mm x 1,880 mm x 1,095 mm	131" x 79" x 43" 3,330 mm x 2,010 mm x 1,095 mm	

QUARTZ HALOGEN



AC	LIGHTING	POWER REQUIREMENTS	OUTPUT (PER LIGHT)	TOTAL OUTPUT	HxWxD (NESTED)	HxWxD (UPRIGHT)	WT.
CL607A-HQ	Hubbell Quartzlitter 750W	115V or 230V AC 4,800W	16,500 lumens	99,000 lumens	12" x 74" x 42" 305 mm x 1,880 mm x 1,065 mm	131" x 79" x 42" 3,330 mm x 2,010 mm x 1,065 mm	305 lbs 139 kg
CL611A-HQ	Hubbell Quartzlitter 1,000W	230V AC 6,300W	21,500 lumens	129,000 lumens	12" x 74" x 42" 305 mm x 1,880 mm x 1,065 mm	131" x 79" x 42" 3,330 mm x 2,010 mm x 1,065 mm	
CL615A-HQ	Hubbell Quartzlitter 1,500W	230V AC 9,300W	20,261 lumens	81,044 lumens	12" x 74" x 42" 305 mm x 1,880 mm x 1,065 mm	131" x 79" x 42" 3,330 mm x 2,010 mm x 1,065 mm	

8 HEAD



THE CL SERIES towers are Command Light's largest units with a reach up to 11 feet from its base, ideal for large command vehicles. These light towers, manufactured using aircraft-grade aluminum, can rotate 360° and tilt, raise and lower with ease to mitigate shadows in all types of situations. Unlike vehicle-mounted perimeter LEDs, this gives officers the ability to direct all usable light. A tower even can be angled to overhang the vehicle to provide operable light near the side of the unit.

OPTIONS (SEE PAGE 3 FOR DESCRIPTIONS)

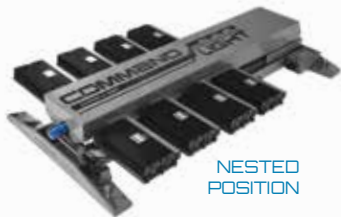

NESTED POSITION



Whelen Pioneer Plus PFP4

LEDs

AC	LIGHTING	POWER REQUIREMENTS	OUTPUT (PER LIGHT)	TOTAL OUTPUT	HxWxD (NESTED)	HxWxD (UPRIGHT)	WT.
CL802A-W4	Whelen Pioneer Plus PFP4 300W	115V or 230V AC 2,700W	40,884 lumens	327,072 lumens	12" x 74" x 43" 305 mm x 1,880 mm x 1,095 mm	131" x 79" x 43" 3,330 mm x 2,010 mm x 1,095 mm	325 lbs 147 kg

4 HEAD

LEDs



OPTIONS (SEE PAGE 3 FOR DESCRIPTIONS)



* On this DC tower, amperage only allows for one of these options.



NESTED POSITION



FRC Spectra

Whelen Pioneer Plus PFH2

DC	LIGHTING	POWER REQUIREMENTS	OUTPUT (PER LIGHT)	TOTAL OUTPUT	HxWxD (NESTED)	HxWxD (UPRIGHT)	WT.
CL602D-FS	FRC Spectra 220W	12V DC - 88 amps 1,050W	20,000 lumens	80,000 lumens	12" x 74" x 43" 305 mm x 1,880 mm x 1,095 mm	131" x 79" x 43" 3,330 mm x 2,010 mm x 1,095 mm	305 lbs 139 kg
CL602D-W2	Whelen Pioneer Plus PFH2 150W	12V DC - 63 amps 600W	18,520 lumens	74,080 lumens	12" x 74" x 43" 305 mm x 1,880 mm x 1,095 mm	131" x 79" x 43" 3,330 mm x 2,010 mm x 1,095 mm	

KL SERIES

TOWERS WITH 7.5-FOOT REACH

THE KNIGHT SERIES, Command Light's mid-size tower, delivers a reach of nearly 7.5 feet from its base. Like the CL Series, the KL Series offers tilt and 360° rotation. Plus, these units are manufactured using aircraft-grade aluminum and yet are roughly half the weight of their taller counterpart, making these towers ideal for vehicles with limited space.

6 HEAD



OPTIONS (SEE PAGE 3 FOR DESCRIPTIONS)



LEDs

AC	LIGHTING	POWER REQUIREMENTS	OUTPUT (PER LIGHT)	TOTAL OUTPUT	HXWXD (NESTED)	HXWXD (UPRIGHT)	WT.
KL415A-CH	Helios 60W	115V or 230V AC 660w	14,000 lumens	84,000 lumens	12" x 47" x 34" 305 mm x 1,195 mm x 865 mm	87.5" x 52" x 34" 2,225 mm x 1,320 mm x 865 mm	165 lbs 75 kg
KL415A-FS	FRC Spectra 220W	115V or 230V AC 1,620w	20,000 lumens	120,000 lumens	12" x 47" x 34" 305 mm x 1,195 mm x 865 mm	87.5" x 52" x 34" 2,225 mm x 1,320 mm x 865 mm	
KL415A-W2	Whelen Pioneer Plus PFP2 150W	115V or 230V AC 1,200w	20,442 lumens	122,652 lumens	12" x 47" x 34" 305 mm x 1,195 mm x 865 mm	87.5" x 52" x 34" 2,225 mm x 1,320 mm x 865 mm	

DC	LIGHTING	POWER REQUIREMENTS	OUTPUT (PER LIGHT)	TOTAL OUTPUT	HXWXD (NESTED)	HXWXD (UPRIGHT)	WT.
KL415D-CH	Helios 60W	12V DC - 55 amps 660W	14,000 lumens	84,000 lumens	12" x 47" x 34" 305 mm x 1,195 mm x 865 mm	87.5" x 52" x 34" 2,225 mm x 1,320 mm x 865 mm	165 lbs 75 kg
KL408D-W1	Whelen Pioneer Plus PCH1 75W	12V DC - 63 amps 750W	10,130 lumens	60,780 lumens	12" x 47" x 23" 305 mm x 1,195 mm x 584 mm	87.5" x 52" x 23" 2,225 mm x 1,320 mm x 584 mm	

QUARTZ HALOGEN



AC	LIGHTING	POWER REQUIREMENTS	OUTPUT (PER LIGHT)	TOTAL OUTPUT	HXWXD (NESTED)	HXWXD (UPRIGHT)	WT.
KL475A-FF	FRC Focus 750W	115 or 230V AC 4,800W	19,600 lumens	117,600 lumens	13" x 47" x 25" 330 mm x 1,195 mm x 635 mm	87.5" x 52" x 25" 2,225 mm x 1,320 mm x 635 mm	165 lbs 75 kg
KL450A-LF	Lumenform 500W	115 or 230V AC 3,300W	11,100 lumens	66,600 lumens	12" x 47" x 23" 305 mm x 1,195 mm x 585 mm	87.5" x 52" x 23" 2,225 mm x 1,320 mm x 585 mm	

4 HEAD



* On this DC tower, amperage only allows for one of these options.



LEDs

DC	LIGHTING	POWER REQUIREMENTS	OUTPUT (PER LIGHT)	TOTAL OUTPUT	HXWXD (NESTED)	HXWXD (UPRIGHT)	WT.
KL415D-FE	FRC Evolution 160W	12V DC - 60 amps 940W	20,000 lumens	80,000 lumens	14" x 47" x 31" 355 mm x 1,195 mm x 787 mm	87.5" x 52" x 31" 2,225 mm x 1,320 mm x 787 mm	165 lbs 75 kg
KL415D-FS	FRC Spectra 220W	12V DC - 84 amps 1,180W	20,000 lumens	80,000 lumens	12" x 47" x 34" 305 mm x 1,195 mm x 865 mm	87.5" x 52" x 34" 2,225 mm x 1,320 mm x 865 mm	
KL415D-LX	Lightforce HTX LED/HID 150W	12V DC - 60 amps 900W	13,500 lumens	54,000 lumens	14" x 47" x 31" 355 mm x 1,195 mm x 787 mm	87.5" x 52" x 31" 2,225 mm x 1,320 mm x 787 mm	
KL415D-W2	Whelen Pioneer Plus PPH2 150W	12V DC - 63 amps 900W	20,261 lumens	81,044 lumens	12" x 47" x 34" 305 mm x 1,195 mm x 865 mm	87.5" x 52" x 34" 2,225 mm x 1,320 mm x 865 mm	

KL SERIES SLIM

The Knight Slim delivers the Knight Series smallest footprint, stowing flat at just 12" x 13" x 53" thanks to this narrow design, ideal for smaller to mid-size vehicles. This compact tower packs a total output of 70,000 lumens thanks to FireTech fixtures.



OPTIONS (SEE PAGE 3 FOR DESCRIPTIONS)



* On this DC tower, amperage only allows for one of these options.



LEDs

AC	LIGHTING	POWER REQUIREMENTS	OUTPUT (PER LIGHT)	TOTAL OUTPUT	HXWXD (NESTED)	HXWXD (UPRIGHT)	WT.
KL409A-H4	(2) HiViz - 270W (2) HiViz - 60W	115V AC 960W	270W: 28,500 60W: 6,500	70,000 lumens	12" x 13" x 53" 305 mm x 330 mm x 1,346 mm	87.5" x 13" x 53" 2,225 mm x 330 mm x 1,346 mm	165 lbs 75 kg
DC	LIGHTING	POWER REQUIREMENTS	OUTPUT (PER LIGHT)	TOTAL OUTPUT	HXWXD (NESTED)	HXWXD (UPRIGHT)	WT.
KL409D-H4	(2) HiViz - 270W (2) HiViz - 60W	12V DC 960W	270W: 28,500 60W: 6,500	70,000 lumens	12" x 13" x 53" 305 mm x 330 mm x 1,346 mm	87.5" x 13" x 53" 2,225 mm x 330 mm x 1,346 mm	165 lbs 75 kg

* Knight Slim requires 18" x 7" x 5" electrical box (mounted nearby).

SL SERIES

THE SHADOW SERIES is Command Light's most compact unit when space is at a premium. These towers have a reach of more than 4 feet from its base (or 6.5' with optional 80" arm), weigh approximately 65 lbs, and are still manufactured using aircraft-grade aluminum alloy for strength. Thanks to this compact size, these units can fit on SUVs, vans and pickup trucks, all the while featuring 355° of rotation.



LIGHTFORCE HTX SPOTLIGHTS Command Light has partnered with Lightforce Lights to deliver the Knight Series KL415D-LX and the Shadow Series SL442D-LX for the industry's best long-distance light. Both towers tout four Lightforce HTX spotlights for extreme long-distance viewing, allowing officers to further themselves from dangerous scenes, while providing rural districts a long-distance beam when terrain prevents an easy approach to the incident.

See installation footage at bit.ly/lightforceHTXinstall

SL442D-LX

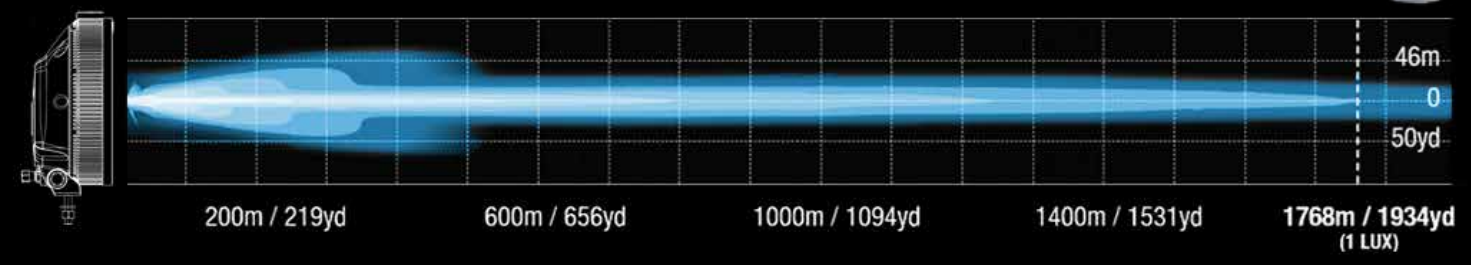

QUESTIONS? CUSTOM TOWER INQUIRIES? CONTACT US AT INFO@COMMANDLIGHT.COM

TOWERS WITH 4.5- TO 6.5-FOOT REACH

4 HEAD

OPTIONS (SEE PAGE 3 FOR DESCRIPTIONS)



LEDs



AC/DC	LIGHTING	POWER REQUIREMENTS	OUTPUT (PER LIGHT)	TOTAL OUTPUT	HXWXD (NESTED)	HXWXD (UPRIGHT)	WT.
SL442A-CH	Helios 60W	12V DC - 115V or 230V AC 420W	14,000 lumens	56,000 lumens	8" x 54" x 34" 205 mm x 1,375 mm x 865 mm	55" x 36" x 34" 1,395 mm x 915 mm x 865 mm	75 lbs 35 kg
SL442A-FS	FRC Spectra 220W	12V DC - 115V or 230V AC 1,060W	20,000 lumens	80,000 lumens	8" x 54" x 34" 205 mm x 1,375 mm x 865 mm	55" x 36" x 34" 1,395 mm x 915 mm x 865 mm	
SL442A-W2	Whelen Pioneer Plus PFP2 150W	12V DC - 115V or 230V AC 780W	20,442 lumens	81,768 lumens	8" x 54" x 33" 205 mm x 1,375 mm x 835 mm	55" x 36" x 33" 1,395 mm x 915 mm x 835 mm	

DC	LIGHTING	POWER REQUIREMENTS	OUTPUT (PER LIGHT)	TOTAL OUTPUT	HXWXD (NESTED)	HXWXD (UPRIGHT)	WT.
SL442D-CH	Helios 60W	12V DC - 35 amps 420W	14,000 lumens	56,000 lumens	8" x 54" x 34" 205 mm x 1,375 mm x 865 mm	55" x 36" x 34" 1,395 mm x 915 mm x 865 mm	75 lbs 35 kg
SL442D-FE	FRC Evolution 160W	12V DC - 70 amps 820W	20,000 lumens	80,000 lumens	8" x 54" x 32" 205 mm x 1,375 mm x 815 mm	55" x 36" x 32" 1,395 mm x 915 mm x 815 mm	
SL442D-FS	FRC Spectra 220W	12V DC - 90 amps 1,060W	20,000 lumens	80,000 lumens	8" x 54" x 34" 205 mm x 1,375 mm x 865 mm	55" x 36" x 34" 1,395 mm x 915 mm x 865 mm	
SL442D-LX	Lightforce HTX LED/HID 150W	12V DC - 65 amps 780W	13,500 lumens	54,000 lumens	8" x 56" x 23" 203 mm x 1,422 mm x 584 mm	57" x 46" x 23" 1,448 mm x 1,169 mm x 584 mm	
SL442D-W1	Whelen Pioneer Plus PCH1 75W	12V DC* - 40 amps 480W	10,130 lumens	40,520 lumens	8" x 54" x 22" 205 mm x 1,375 mm x 559 mm	55" x 36" x 22" 1,395 mm x 915 mm x 559 mm	
SL442D-W2	Whelen Pioneer Plus PFH2 150W	12V DC* - 60 amps 780W	20,261 lumens	81,044 lumens	8" x 54" x 33" 205 mm x 1,375 mm x 835 mm	55" x 36" x 33" 1,395 mm x 915 mm x 835 mm	

SEE PAGE 15 FOR INFO ON THE ABOVE TRAFFIC LIGHT BAR ADDITION

QUARTZ HALOGEN

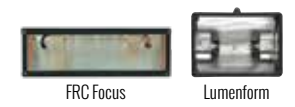

AC/DC	LIGHTING	POWER REQUIREMENTS	OUTPUT (PER LIGHT)	TOTAL OUTPUT	HXWXD (NESTED)	HXWXD (UPRIGHT)	WT.
SL447A-FF	FRC Focus 750W	12V DC - 115V or 230V AC 3,180W	19,600 lumens	78,400 lumens	8" x 54" x 23" 205 mm x 1,375 mm x 585 mm	49.5" x 52" x 23" 1,260 mm x 1,320 mm x 585 mm	70 lbs 32 kg
SL445A-LF	Lumenform 500W	12V DC - 115V or 230V AC 2,180W	11,100 lumens	44,400 lumens	8" x 54" x 22" 205 mm x 1,375 mm x 560 mm	55" x 36" x 22" 1,395 mm x 915 mm x 560 mm	

SL SERIES



LEDs

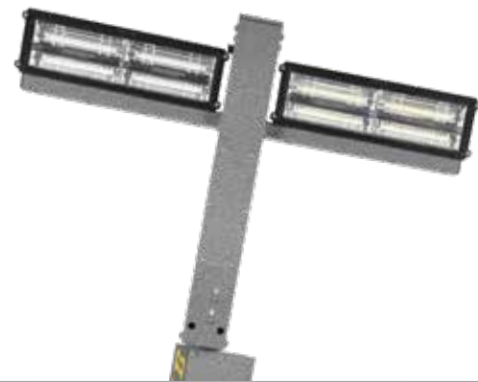

TOWERS WITH 4.5-6.5-FOOT REACH

OPTIONS (SEE PAGE 3 FOR DESCRIPTIONS)



DC	LIGHTING	POWER	OUTPUT (PER LIGHT)	TOTAL OUTPUT	HXWXD (NESTED)	HXWXD (UPRIGHT)	WT.
SL422D-FS	FRC Spectra 230W	12V DC - 42 amps 620W	20,000 lumens	40,000 lumens	8" x 54" x 34" 205 mm x 1,375 mm x 865 mm	55" x 36" x 34" 1,395 mm x 915 mm x 865 mm	65 lbs 30 kg
SL422D-W2	Whelen Pioneer Plus PFH2 150W	12V DC* - 35 amps 480W	20,261 lumens	40,522 lumens	8" x 54" x 33" 205 mm x 1,375 mm x 840 mm	55" x 36" x 33" 1,395 mm x 915 mm x 840 mm	

SL SERIES STRAIGHT SHADOW
TOWERS WITH 3.5-FOOT REACH

The Straight Shadow is Command Light's most economical solution in maintaining efficient scene lighting. Featuring only elevated capabilities (and not rotation), this unit offers a 3.5' reach from its base. The Straight Shadow can also be easily modified to elevate cameras and antennas.

OPTIONS (SEE PAGE 5 FOR DESCRIPTIONS)



LEDs



DC	LIGHTING	POWER REQUIREMENTS	OUTPUT (PER LIGHT)	TOTAL OUTPUT	HXWXD (NESTED)	HXWXD (UPRIGHT)	WT.
SS322D-CH	(2) Helios 60W	12V DC - 20 amps 240W	14,000 lumens	28,000 lumens	9" x 42" x 30" 230 mm x 1,065 mm x 762 mm	43" x 45" x 30" 1,092 mm x 1,143 mm x 762 mm	45 lbs 20 kg
SS322D-W2	(2) Whelen Pioneer Plus PFH2 - 150W	12V DC - 34 amps 420W	20,261 lumens	40,522 lumens	8" x 42" x 30" 205 mm x 1,067 mm x 760 mm	43" x 45" x 30" 1,092 mm x 1,143 mm x 760 mm	

C-LITE

COMPACT LIGHTING



Whether you're searching for a suspect or responding to a nighttime motor vehicle accident, equip your officers with the most versatile police car spotlight – **THE COMMAND LIGHT C-LITE**. This compact light features an LED spotlight/floodlight combo, 120° of tilt and optional rotation to illuminate areas not typically reached by fixed lights.

OPTIONS



LEDs

DC	LIGHTING	POWER REQUIREMENTS	OUTPUT (PER LIGHT)	TOTAL OUTPUT	HXWXD (NESTED)	HXWXD (UPRIGHT)	WT.
CD113D-CH	(1) Helios 60W	12V DC - 12 amps 140W	14,000 lumens	14,000 lumens	9" x 14" x 19" 229 mm x 355 mm x 483 mm	21" x 14" x 19" 533 mm x 355 mm x 483 mm	30 lbs 14 kg
CD113D-FS	(1) FRC Spectra 220W	12V DC - 25 amps 300W	20,000 lumens	20,000 lumens	9" x 14" x 19" 229 mm x 355 mm x 483 mm	21" x 14" x 19" 533 mm x 355 mm x 483 mm	
CD127D-W1	(2) Whelen Pioneer Plus PCH1 75W	12V DC - 19.5 amps 230W	10,130 lumens	20,260 lumens	9" x 19" x 19" 229 mm x 483 mm x 470 mm	21" x 19" x 19" 508 mm x 482 mm x 482 mm	
CD128D-FN	(2) FRC Mini Spectra 130W	12V DC - 29 amps 240W	14,000 lumens	28,000 lumens	9" x 26" x 19" 229 mm x 660 mm x 470 mm	21" x 26" x 19" 533 mm x 660 mm x 470 mm	



THE SHADOW SERIES can fit on SUVs, vans and pickup trucks.

Z-LIFT



LIGHT BAR ELEVATION



See the Z-Lift in action at commandlight.com/z-lift.

THE Z-LIFT Improve visibility by elevating your vehicle's warning lights above the roofline with Command Light's Z-Lift. This lift includes an umbilical remote with auto-deploy and auto-park feature. With the press of a button, the lift can be auto-deployed to be square or rotated 45° or 90° to save time.

- Elevates 40" in 10 seconds
- Rotates 90° (left and right), allowing the lightbar to be positioned toward oncoming traffic

DC	POWER REQUIREMENTS	HXWXD (NESTED)	HXWXD (UPRIGHT)	WT.
Z-LIFT	12V DC - 17 amps 200W	6" x 22" x 47" 155 mm x 560 mm x 1,195 mm	43" x 22" x 75" 1,092 mm x 560 mm x 1,905 mm	62 lbs 28 kg



ADVISORY

TRAFFIC FLOW BOARDS

TRAFFIC FLOW BOARDS With rotational capabilities and multiple arrow patterns, Command Light's Traffic Flow Boards significantly improve on-scene visibility and officer safety while conserving space when stowed. The versatile mounting system gives crews the ability to choose from three different traffic patterns. Each model comes with standard rotation, giving officers the ability to position traffic advisory arrows toward traffic to maximize safety when blocking traffic.

OUR MOST COMPACT FLOW BOARD

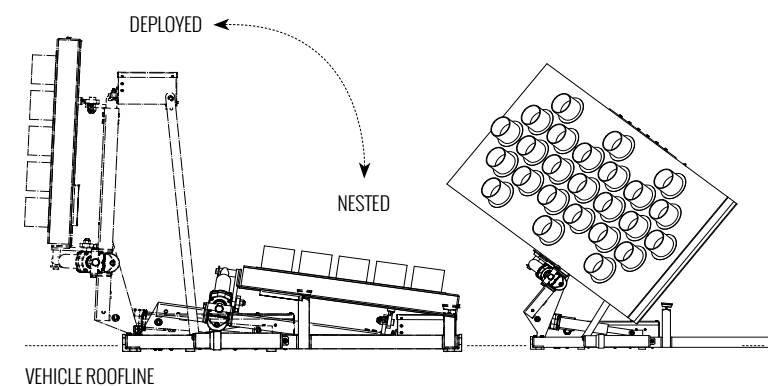

FOLD-DOWN DESIGN H MODELS

The H Model features a fold-down design that mounts to the vehicle to create a low-profile. Once deployed, the flow board can be rotated toward oncoming traffic.



AVAILABLE IN THREE DIFFERENT TRAFFIC PATTERNS

TFB-H7

7 SERIES
Offers the greatest variety of traffic patterns.

TFB-H5

This board can also be mounted to a CL Series tower (TFB-CL5).

TFB-CL5

5 SERIES
Offers essential traffic patterns in a lighter design.

TFB-SL3

This advisor mounts to the top of a SL Series light tower (TFB-SL3).

3 SERIES
Provides a pulsing movement to guide traffic.

DC	MOVEMENT	TRAFFIC PATTERN	POWER REQUIREMENTS	HXWXD (NESTED)	HXWXD (UPRIGHT)	WT.
TFB-H7	Fold-down design	Greatest variety of traffic patterns	12V DC - 5 amps	16" x 60" x 46" 406 mm x 1,524 mm x 1,168 mm	44" x 60" x 66" 1,118 mm x 1,524 mm x 1,676 mm	150 lbs 68 kg
TFB-H5	Fold-down design	Essential traffic patterns	12V DC - 5 amps	8" x 48" x 40" 203 mm x 1,219 mm x 1,016 mm	52" x 70" x 40" 1,321 mm x 1,778 mm x 1,016 mm	80 lbs 36 kg
TFB-CL5	Fold-down design, mounted to a CL Series tower	Essential traffic patterns	12V DC - 5 amps + tower requirements	Variable based on tower selection	Variable based on tower selection	28 lbs + tower
TFB-SL3	Fold-down design, mounted to a Shadow Series tower	Directional light bar	12V DC - 5 amps + tower requirements	Variable based on tower selection	Variable based on tower selection	14 lbs + tower

OUR DIFFERENCE.

DEPLOYMENT

- ✓ Feature a patented (US Patent #5303621) movement, allowing endless positions
- ✓ Can overhang the side of a vehicle in Command Light's exclusive streetlight position
- ✓ Deploys fully in less than 15 seconds with the press of a button
- ✓ Stows quickly with a one-touch auto-park feature

DURABILITY

- ✓ 100% electric, meaning no air or hydraulics
- ✓ Operable in ALL weather conditions
- ✓ Virtually maintenance free
- ✓ Built with aircraft-grade aluminum alloy to add strength while reducing weight

INDUSTRY-LEADING 5-YEAR WARRANTY

Command Light products come with an industry-leading, five-year warranty against any defects in materials and workmanship when used and operated for a period of five years. Excludes malfunctions related to misuse, accident, neglect or normal wear-and-tear, as well as light-producing components (bulbs, lasers, LEDs), which come with their own manufacturer's warranty.



COMMAND LIGHT

COMMANDLIGHT.COM | 800.797.7974 | 3842 REDMAN DR. FORT COLLINS CO 80524

See a Command Light representative or authorized dealer for details. All information in this brochure is the latest available at the time of publication. Printed in the USA. 1K 0720 ©2020 Command Light